

NEW ELECTROSTATIC SENSOR

EF-S1_{SERIES}

A new approach to static electricity countermeasures

Measurement of surface potentials while a production line is running

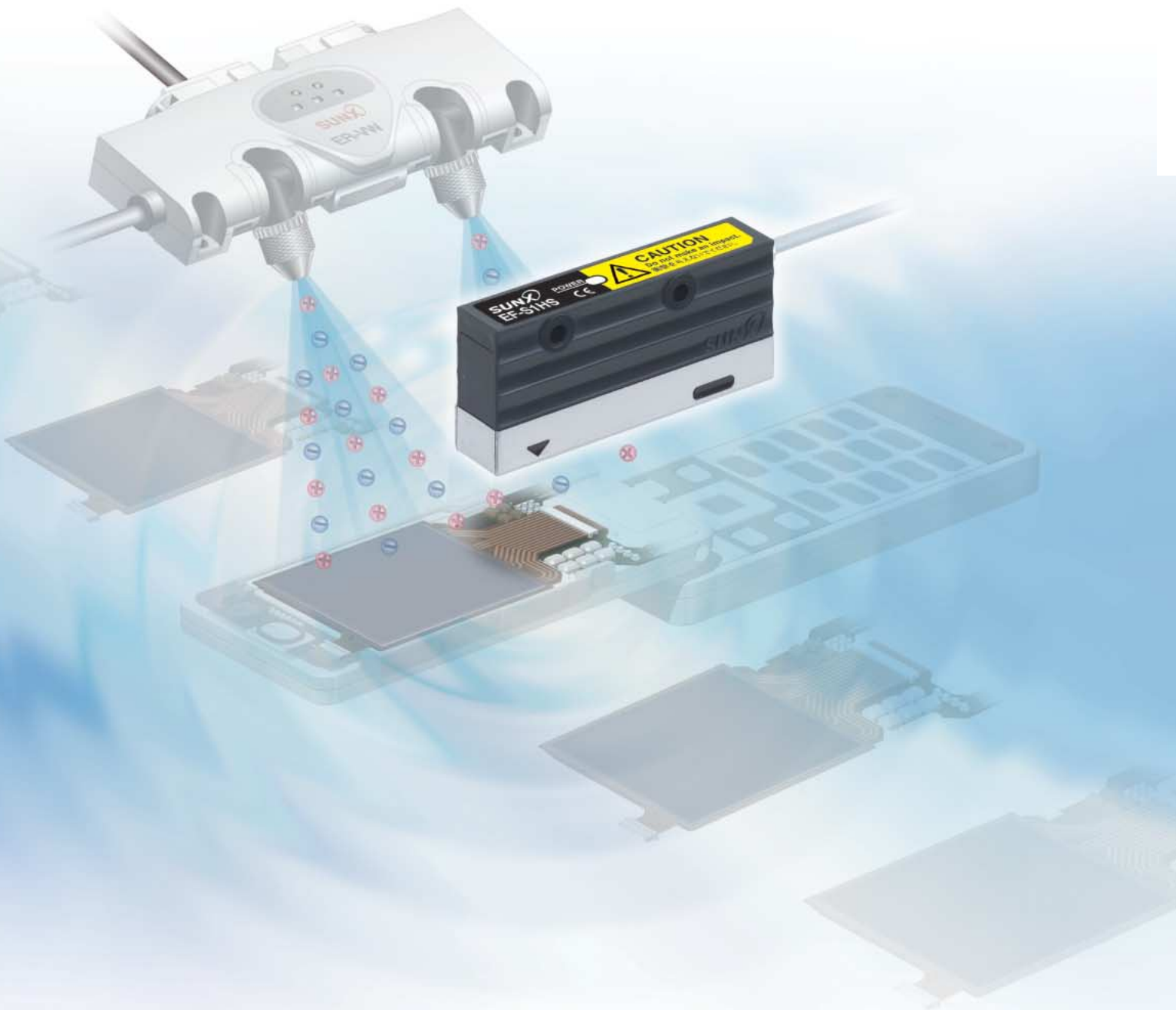

With the EF-S1 series, constant checking of static electricity is possible while a production line is running.

Managing static electricity is commonly a difficult task in workplaces where high-density, high-precision electrical equipment is being assembled.

Static electricity cannot be seen with the eye, so measurement of surface potentials while the production line is running using the EF-S1 series provides a new way to assess its levels accurately so that it can be constantly managed.

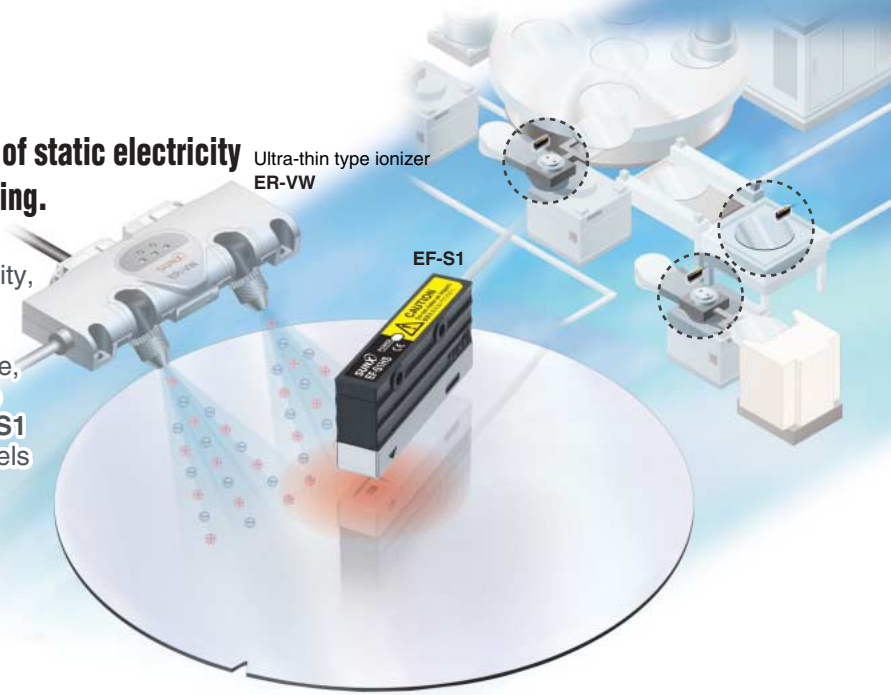

Easy-to-read 2-color dual display

The controller is equipped with a red and a green display. Current values and threshold values can be viewed at a glance.

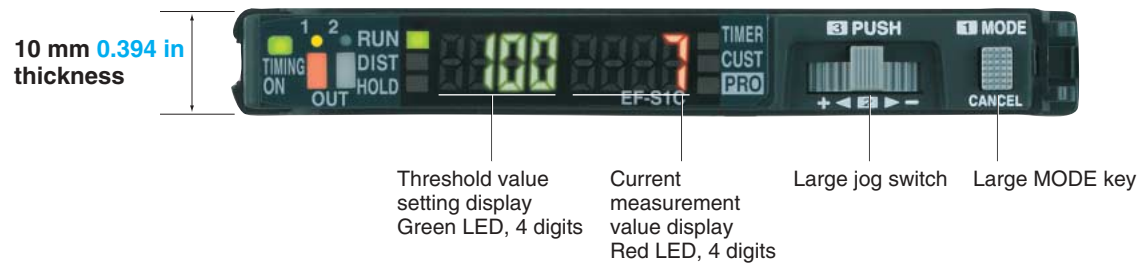

Suitable for measuring under severe conditions

High-precision design with a repeatability precision of $\pm 0.3\%$ F.S. Even very slight differences in potential will not be skipped over.

A variety of functions for a wide range of applications

A large number of functions for a variety of applications are available, including 0-adjust, hysteresis setting, window comparator output, and + potential / - potential peak hold (external timing input) measurement.

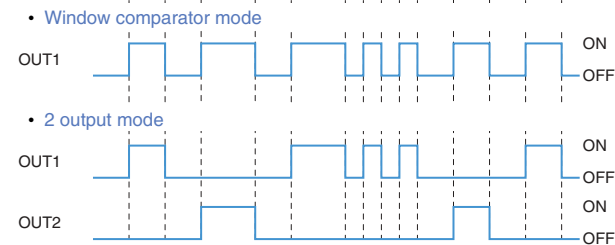
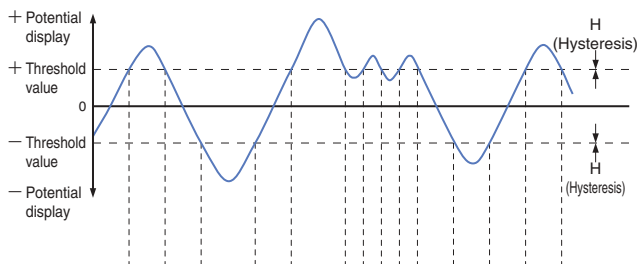

Lightweight and compact for easy setup in any location

The sensor head only weighs 90 g. Installation can be carried out easily using just a bracket so that it is suitable for use in a wide variety of applications.

In addition, power consumption is low so the devices can be utilized without concerns of high running costs.

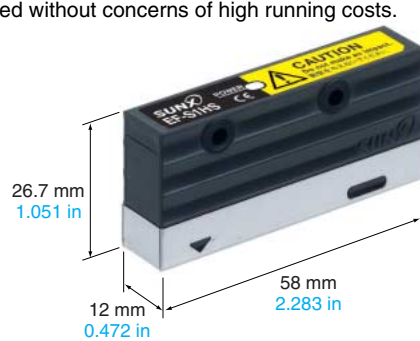

Easy data management using analog output

A device such as a data logger can be used to collect and analyze data, which is useful when carrying out inspections of factors such as ionizer setup angle and the number of devices installed.

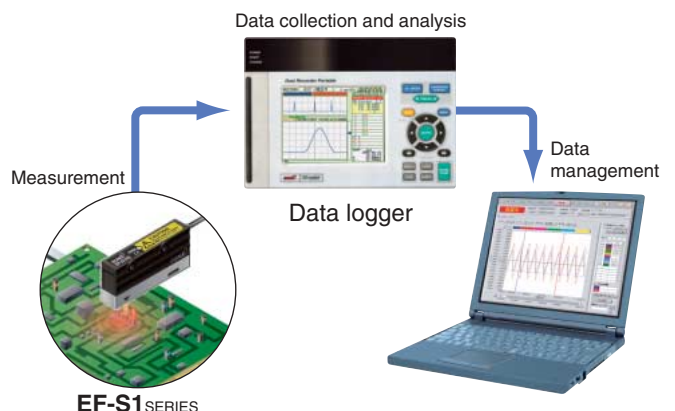

EF-S1 SERIES

APPLICATIONS

Surface potential measurement when releasing BG sheets

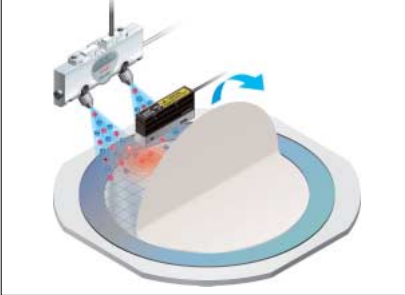

Surface potential measurement during chip release electrification

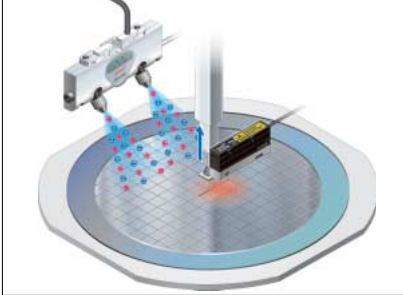

Surface potential measurement during loading and unloading

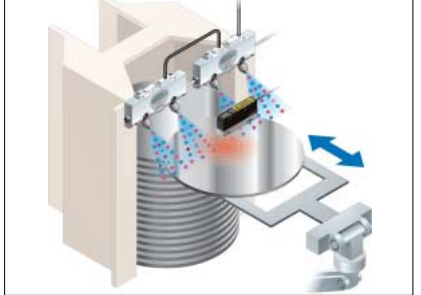

Measurement of lead frame charge removal

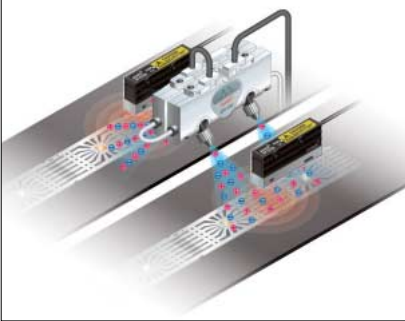

Measurement of frictional electrification of printed circuit boards

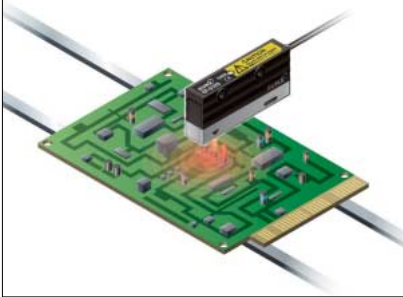

Measurement of frictional electrification of LCD modules

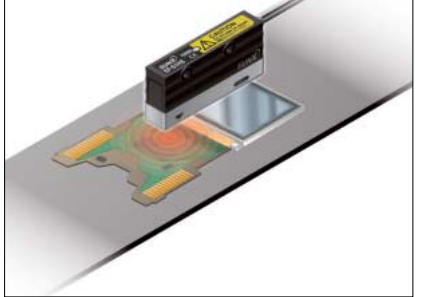

ORDER GUIDE

Sensor head

Appearance	Model No.	Measurement range
	EF-S1HS	8.0 to 20.5 mm 0.315 to 0.807 in (± 1 kV range mode) 21.0 to 40.5 mm 0.827 to 1.594 in (± 2 kV range mode) (Note)

Note: Set a fixed measurement distance between the sensor head and the workpiece and set this distance into the controller before use.

Controller

Appearance	Model No.	Output type
	EF-S1C	NPN open-collector transistor Analog output · Output voltage: 1 to 5 V

Accessories

CN-EP1 (Connector for controller) **5 pcs. per set** (Note)

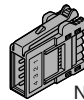

Note: One is attached to each sensor head according to standard.

OPTIONS

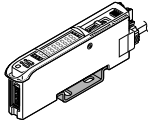
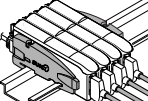
Designation	Appearance	Model No.	Description
Controller mounting bracket		MS-DIN-2	Mounting bracket for controller
End plates		MS-DIN-E	If the controller moves because of the way it has been installed to the DIN rail, use clamps at both sides to secure the controller so that it will not move. 2 pcs. per set

SPECIFICATIONS

Sensor heads

Item	Model No.	EF-S1HS
Applicable controller		EF-S1C
Measurement range (Note 1, 2) (Range mode)		8.0 to 20.5 mm 0.315 to 0.807 in (± 1 kV range mode) 21.0 to 40.5 mm 0.827 to 1.594 in (± 2 kV range mode)
Power indicator		Green LED
Ambient temperature		0 to +40 °C +0 to +104 °F (No dew condensation), Storage: -20 to +60 °C -4 to +140 °F
Ambient humidity		35 to 65 % RH, Storage: 35 to 85 % RH
Vibration resistance		10 to 150 Hz frequency, 0.75 mm 0.030 in amplitude in X, Y and Z directions for two hours each
Shock resistance		98 m/s ² acceleration (10 G approx.) in X, Y and Z directions for five times each
Material		Enclosure: Heat resistant ABS, Measuring part cover: Stainless steel (SUS304)
Cable		0.09 mm ² , 3-core shielded cable, 5 m 16.404 ft long (with controller connector) (Note 3)
Weight		Net weight: 90 g approx., Gross weight: 130 g approx.

Notes: 1) Set a fixed measurement distance between the sensor head and the workpiece and set this distance into the controller before use.
2) The measurement range mode is switched automatically when the measurement range setting is changed at the controller.
3) Cable cannot be extended.

Controller

Item	Model No.	EF-S1C
Applicable sensor heads		EF-S1HS
Supply voltage		24 V DC ± 10 %
Current consumption		Normal operation: 50 mA or less, ECO mode: 40 mA or less
Display range (Note 1) (Range mode)		-1,000 to 1,000 (± 1 kV range mode) -1,999 to 1,999 (± 2 kV range mode)
Repeatability		± 0.3 % F.S.
Linearity		± 0.5 % F.S. (Note 2)
Temperature characteristics		0.05 % F.S. / °C (Note 3)
Judgment outputs (OUT 1, OUT 2)		NPN open-collector transistor <ul style="list-style-type: none"> • Maximum sink current: 100 mA • Applied voltage: 30 V DC or less (between judgment output and 0 V) • Residual voltage: 1.5 V or less (at 100 mA sink current)
Response time		10 ms, 20 ms (STD), 100 ms, 200 ms, 400 ms, 800 ms Switching method
Output operation		OUT1: + potential measurement output or window comparator output OUT2: - potential measurement output or error output
Short-circuit protection		Incorporated
Analog output (Note 4)		• Output voltage: 1 to 5 V • Output impedance: 100 Ω approx.
Response time		20 ms, 30 ms (STD), 110 ms, 210 ms, 410 ms, 810 ms Switching method
Timing input		NPN non-contact input <ul style="list-style-type: none"> • Signal condition High: + V or open, Low: 0 to +2 V (source current 0.5 mA or less) • Input impedance: 10 kΩ approx.
Ambient temperature		-10 to +55 °C +14 to +131 °F (No dew condensation or icing allowed), Storage: -20 to +70 °C -4 to +158 °F
Ambient humidity		35 to 85 % RH, Storage: 35 to 85 % RH
Material		Enclosure: Heat-resistant ABS, Clear cover: Polycarbonate, Push button switch: Acrylic, Jog switch: ABS
Cable		0.2 mm ² 6-core cable, 2 m 6.562 ft long
Cable extension (Note 6)		Extension up to total 10 m 32.808 ft is possible with 0.3 mm ² , or more, cable.
Weight		Net weight: 65 g approx., Gross weight: 110 g approx.

Notes: 1) The display range (measurement range) is switched automatically when the measurement distance setting is changed at the controller.
2) The values given are for when the measured potential is ± 200 V or less in the ± 1 kV range mode and ± 400 V or less in the ± 2 kV range mode. If the measured potentials are outside these values, the values will be equal to the displayed values ± 5 %.
3) The values given are for when the measured potential is ± 200 V or less in the ± 1 kV range mode and ± 400 V or less in the ± 2 kV range mode. If the measured potentials are outside these values, the values will be 0.5 % / °C of the displayed values.
4) In order to satisfy the linearity specifications for the analog output, do not use the judgment output.
5) F.S. is 2,000 V (-1,000 V to 1,000 V) for the ± 1 kV range mode and 4,000 V (-2,000 V to 2,000 V) for the ± 2 kV range mode.
6) This product is CE compliant and complies with EMC directives. EN 61000-6-2 is the applicable standard that covers immunities relating to use of this product, but in order to comply with this standard, the following conditions must be satisfied.
• The controller must be connected to the power supply at a distance of less than 10 m **32.808 ft**.
• Install the ferrite core (accessory) to the cable approximately 30 mm **1.181 in** away from the sensor head (EF-S1HS).

I/O CIRCUIT AND WIRING DIAGRAMS

EF-S1C NPN output

I/O circuit diagram

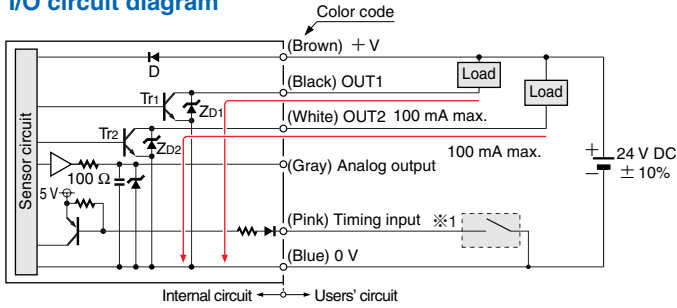

Wiring diagram

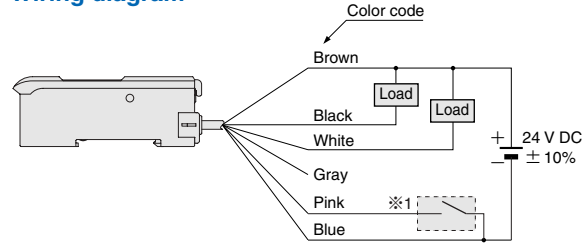

<Points to note when using analog output>
Because the 0 V lines for judgment output and analog output are common, the analog output may vary depending on the load current. In order to satisfy the linearity specifications for the analog output, do not use the judgment output.

Note: If using together with an ionizer, the 0 V line of this product should be connected to the ionizer ground. In addition, the metal parts of the sensor head (EF-S1HS) are connected to the 0 V line, so it should be insulated during installation.

※1

Non-voltage contact or NPN open-collector transistor

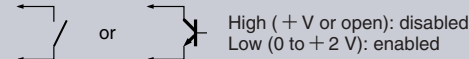

Symbols ... D: Reverse supply polarity protection diode
ZD1, ZD2: Surge absorption zener diode
Tr1, Tr2 : NPN output transistor

※Connector for controller (CN-EP1) pin position

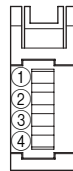

Terminal No.	Connection cable
①	+ V: Brown
②	0 V: Blue
③	Sensor output: Orange / Violet
④	Shield wire

SENSING CHARACTERISTICS (TYPICAL)

EF-S1HS

Measurement range — Field of measurement

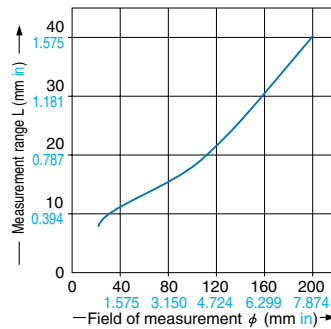
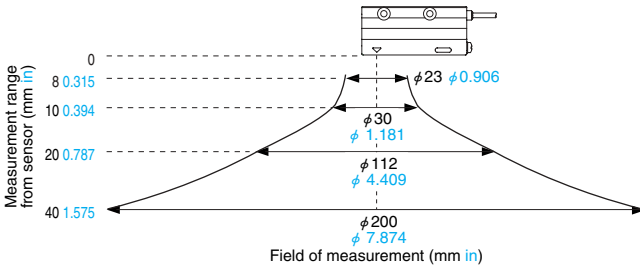

Installation tolerance —

Display value tolerance characteristics

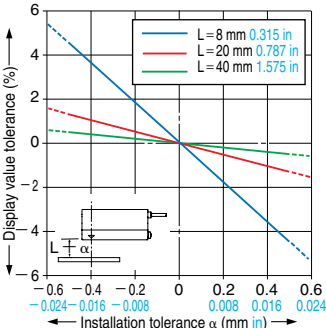

Angular deviation①

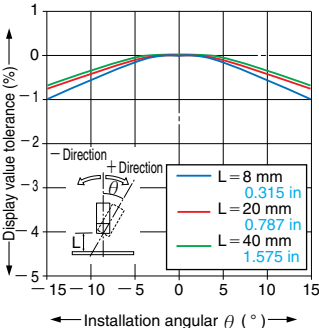

Angular deviation②

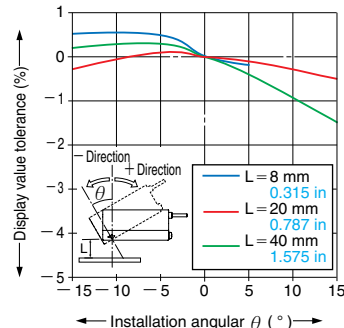

Note: If the installation tolerance is greater than 0.5 mm 0.020 in, change the measurement range setting at the controller.

Note: If the value is tilting toward the positive side, the enclosure is causing interference, so if L = 8 mm 0.315 in, there will be no graph display at 5 degrees or higher.

DIMENSIONS (Unit: mm in)

EF-S1HS Sensor head

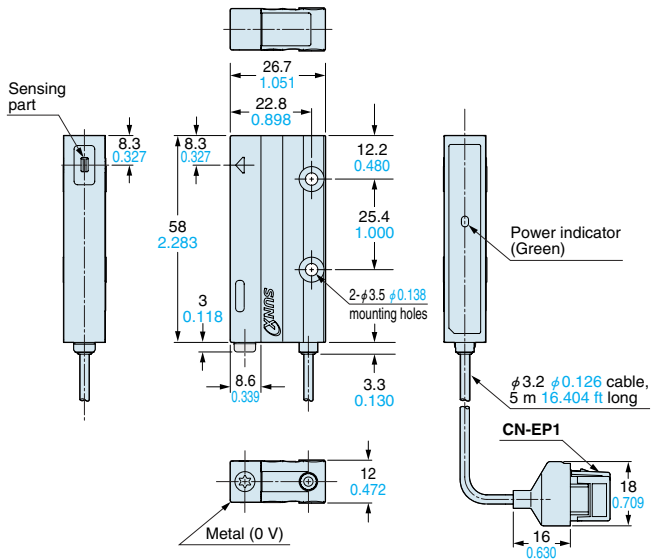

EF-S1C Controller

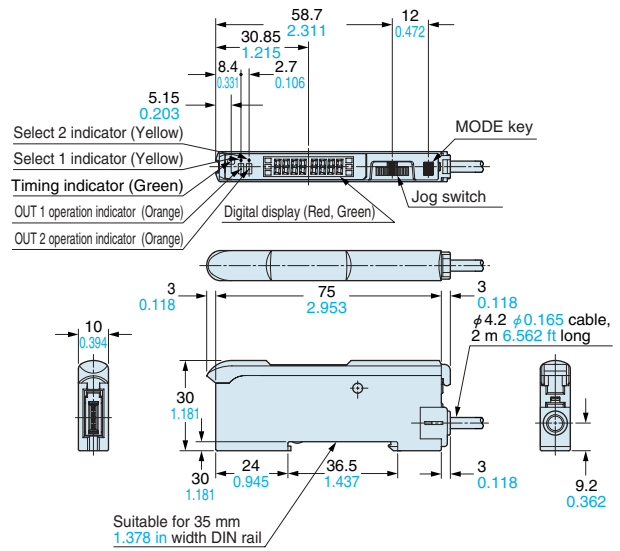

All information is subject to change without prior notice.



<http://www.sunx.co.jp/>

SUNX Limited

2431-1 Ushiyama-cho, Kasugai-shi, Aichi,
486-0901, Japan
Phone: +81-(0)568-33-7211
FAX: +81-(0)568-33-2631

Overseas Sales Dept.

Phone: +81-(0)568-33-7861
FAX: +81-(0)568-33-8591